

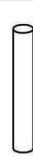















**SRB****UPUTSTVO ZA MONTAŽU PLASTENIKA****Pripadajući delovi, pozicije i količine**

Poz	1	2	3	4	5	6	6A	7	8	9	10	11	12	13	14	15	16	17
																		
Kom	10	5	5	5	15	2	2	2	2	10	25	4	29	1	1	4	4	1

**789.004.00**

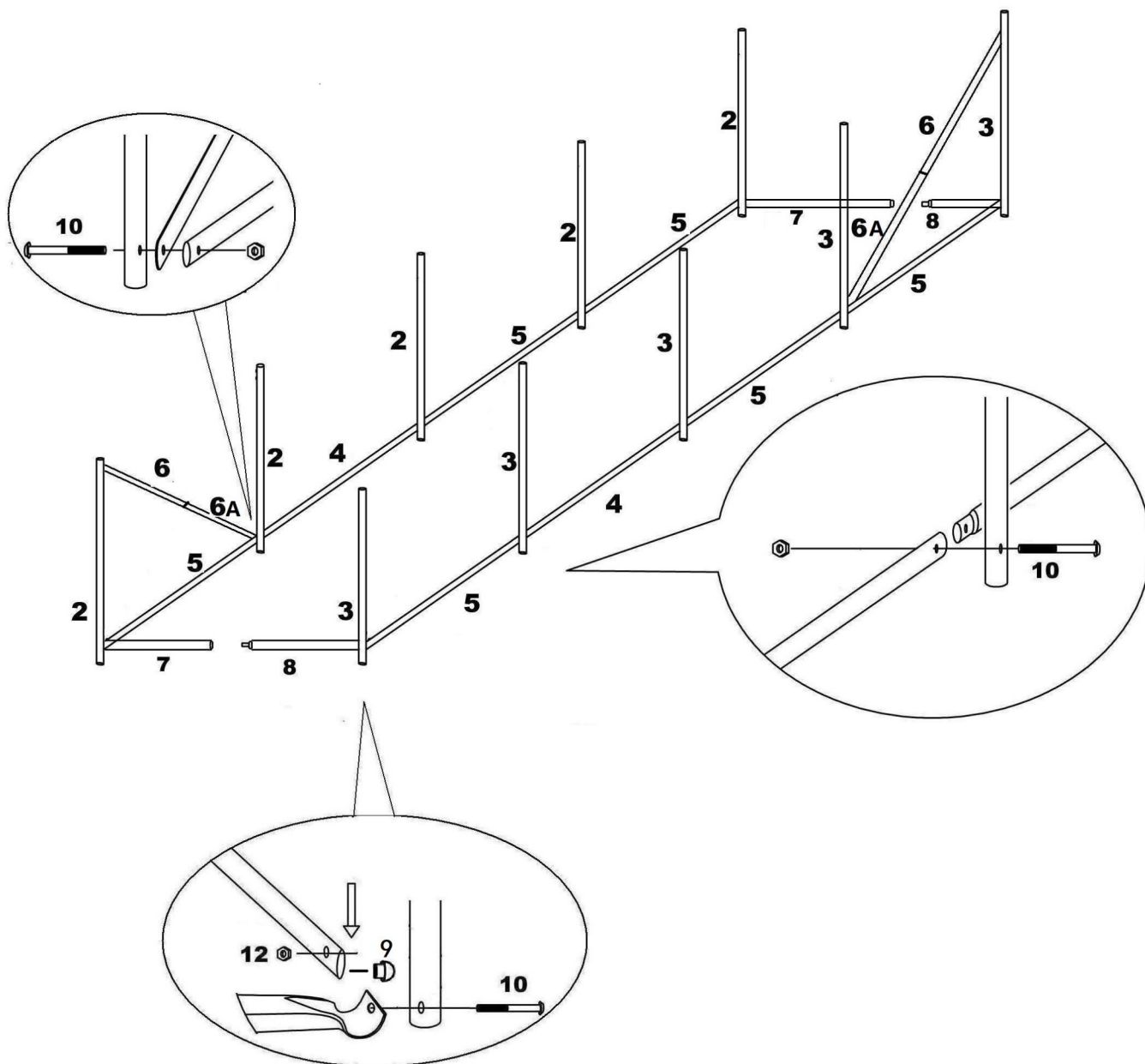

Labavo sastavite kompletan okvir,  
pre zatezanja svih vijaka u krajnjem položaju.

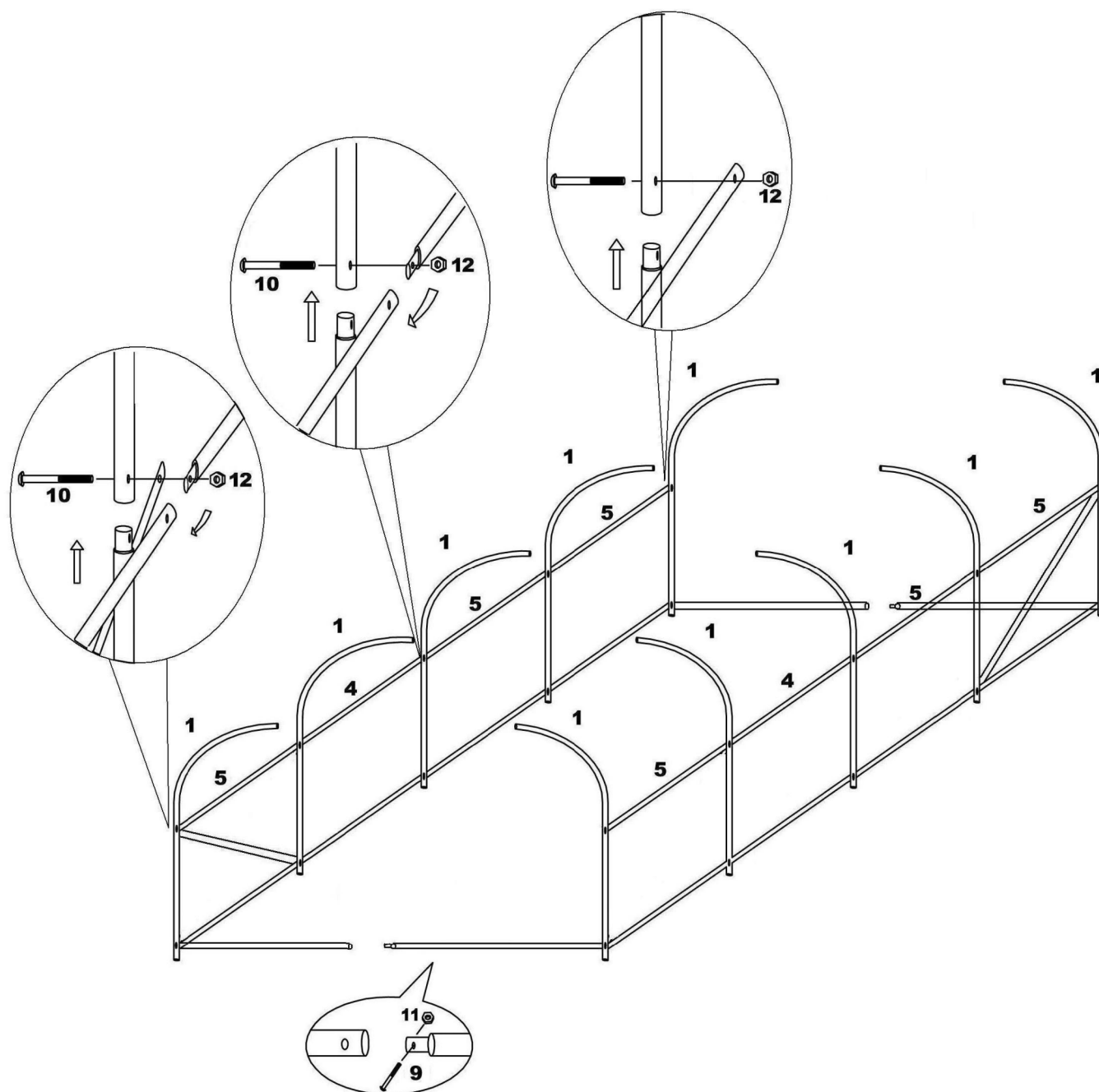

Labavo sastavite kompletan okvir,  
pre zatezanja svih vijaka u krajnjem položaju.

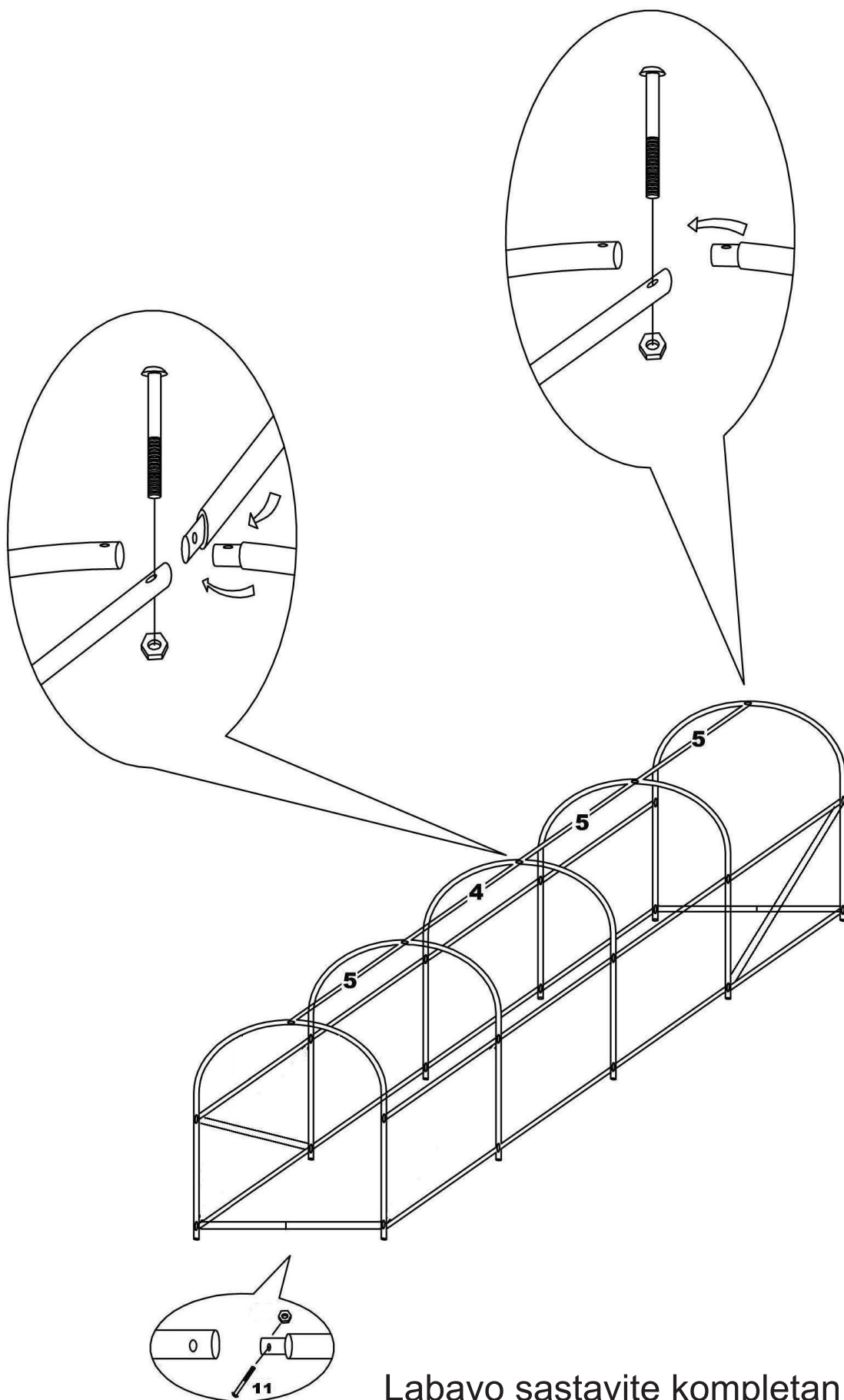

Labavo sastavite kompletan okvir,  
pre zatezanja svih vijaka u krajnjem položaju.

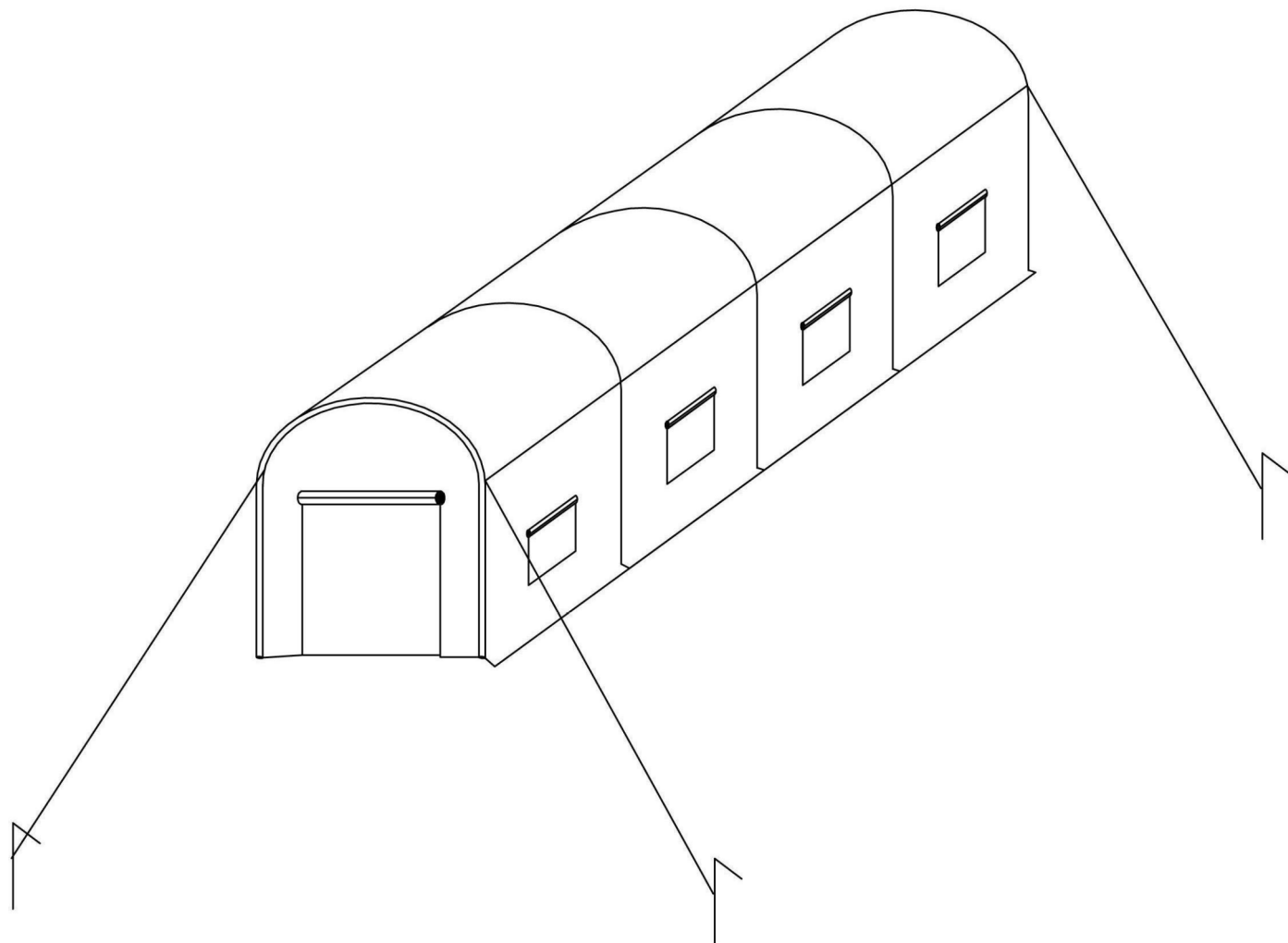
**Napomena:**

- Pažljivo pratite uputstva za montažu i sklapanje.
- 2-3 osobe treba da rade skupa na sklapanju.
- Za maksimalnu stabilnost vašeg plastenika, molimo vas iskopajte rov da zakopate stubove osnovnog okvira i popunite ga nazad pokrivajući poklopce plastične nadstrešnice.